



ECOWOOD - THE FUTURE WOOD

CATALOGUE

TOP COMPOSITE TIMBER PRODUCTS

What is EcoWood?

Ecowood is a WPC (Wood Plastic Composite) material made from 70% plantation forest wood and 30% additives and Plastic.

The 70% wood part of Ecowood is from plantation grown wood. Sawmill waste is collected and turned into wood flour. It then combined with virgin and/or recycled plastic resin, and blended with pigments to make pellets of more than 20 different colours. These pellets are then combined to make a range of products of various colours through a heated extrusion process. The elements and the way they are combined make Ecowood a very durable, stable, attractive, easy to use, recyclable building product.

Ecowood can use for interior and exterior architectural decoration such as outdoor wall panelling, indoor wall panelling, ceiling panel, roofing, louver, flooring, decking, Skirting and much more.

Save our Planet

At Ecowood , we support in using sustainable farm trees.
We are proud to announce that our EcoWood composite products have been accredited by

- Malaysia Green Building Confederation
- Singapore Green Building Council
- Green Building Council Australia

Also, our quality system for design and manufacture has been reached the requirement of ISO 9001:2008



The Manufacturing of Ecowood Product

With its unique formula and manufacturing technics, EcoWood materials are extruded into designed shape and style according to the mold installed. Similar to timber, EcoWood WPC products can be drilled, cut, planed and colored.

Application

Ecowood WPC products can be applied to indoor and outdoor areas as wall panels, sun shading decking, aluminum-WPC system, and fencing & railing.

Architecture Design

From private areas to public buildings or hotels/resorts, Ecowood WPC products were chosen by global users, architects and landscape designers. The exquisite designs and creative applications of Ecowood WPC products provided users unfathomable appeals of visual sense.



AVAILABLE COLORS



Ecowood uses only the finest raw materials to produce

Ecowood products represent the ideal alternative to natural timber. Manufactured predominantly from natural wood, our products help to prevent forest depletion through the sustainable use of recycled material and energy management.

Ecowood's Advantages

Insect Resistant	Environmental Friendly	Weathering Resistant
Fire Resistant	Longevity	Paintable
Water Resistant	Nail/Screw Fixing	Recyclable



Being at the forefront of global composite timber technology, we are proud to be the chosen composite timber supplier of leading national and international architects, designers and builders. Our versatility and product performance are instrumental to the continued success of various projects completed within Vietnam and overseas..

IMAGINE WHAT ECOWOOD COMPOSITE PRODUCTS CAN DO

- Cladding
 - Outdoor Panels/Cladding
 - Decking
 - Sun Shading/Pergola
 - Ceiling
 - Fencing/Railing
 - Gates/Huts
 - Decorative Garden
 - Indoor Flooring
 - Finishing Accessories
- The possibilities are endless





OUTDOOR PANELS/CLADDING

Material: Wood and PVC Composite

Ecwood wall panel can meet most outdoor application requirements with our experienced R&D team. It can add more features to the appearance of building by providing the natural wood grain and texture, fire retardant, anti-UV, water resistant and low maintenance costs.

Specific design and proven performance make Ecwood products an excellent choice for users. Ecwood products combine with high quality and competitive price to set a new industrial standard for value.



QBI-50
154x16mm



QBI-47
152x50mm



QBI-49
207.5x46mm



WPO-300
300x9mm



WPO-109
109x10mm



WPO-96
96x9mm



WPO-90
112x16mm



QBI-65
511.5x10mm



CTI-03
108x10mm



QBI-24
150x13mm



QBI-01
159x9mm



QBO-16
203x25mm



QBO-26
203x25mm



RUSTIC
118x11mm



WPO-120
135x12mm



WPO-125
125x12mm



WPO-165
165x10mm



WPO-121
121x8mm

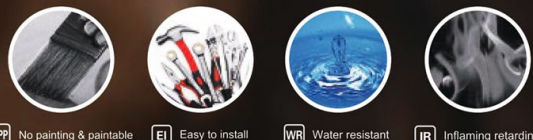
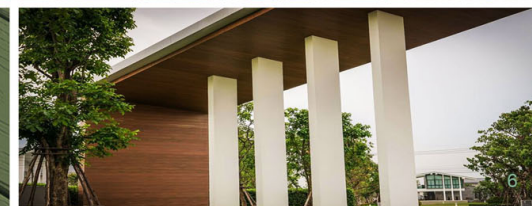
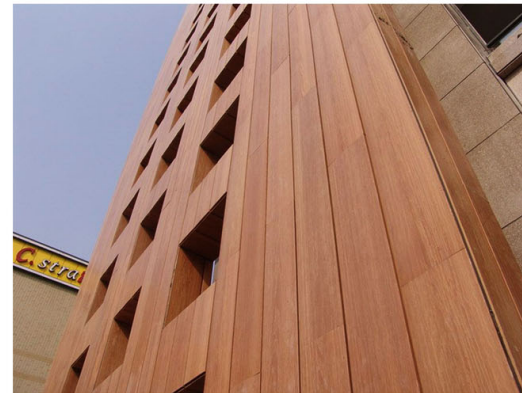



WPO-182
182x29mm



QBI-09
260x28mm



QBI-12
70x15mm



WPO-135
135x8mm



QBI-48
150x17mm



WPO-16518
165x18mm



WPO-200
200x2mm



WPO-63
63x16mm



WPO-213
213x16mm



WPO-105
105x25mm



WPO-75
75x33mm



TJO-05
100x13mm

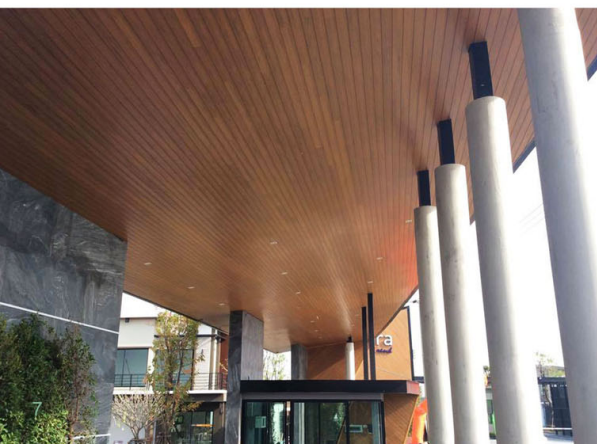
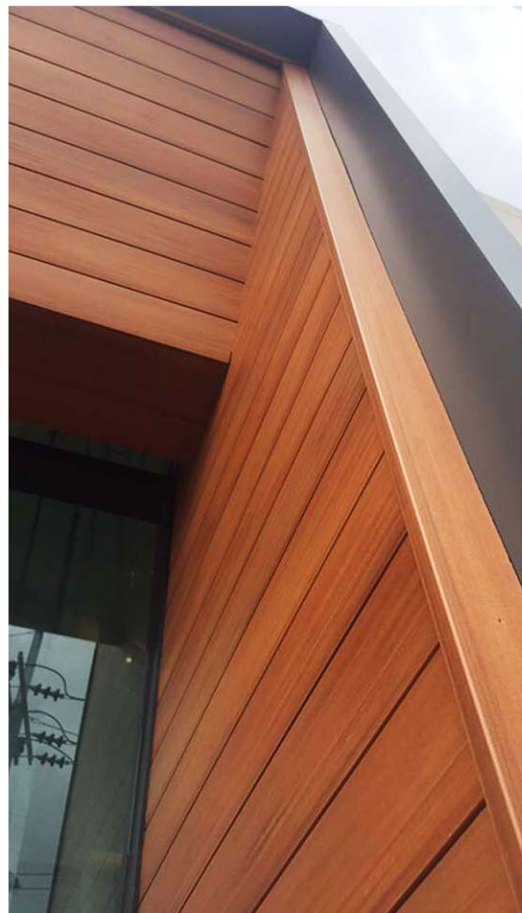

OUTDOOR PANELS/CLADDING



QBI-22
204x30mm



QBI-22B
204x30mm



QBO-37
87x26mm



QBO-37B
120x25mm



QBO-37C
150x25mm



WPO-142
142x20mm



QBI-14
207x16mm



QBI-24030
240x30mm



QBI-05
159x10mm



WPO-198
198x15mm



WPO-202
202x15mm



WPO-25020
250x20mm

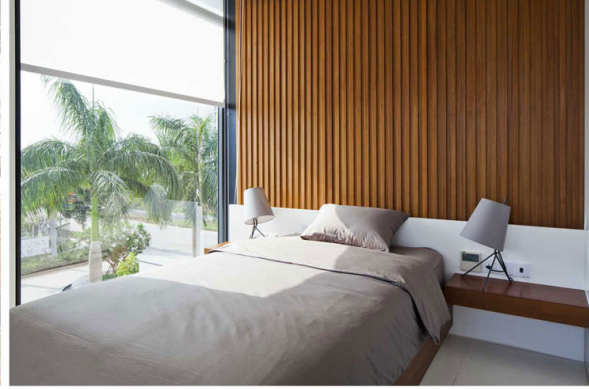

**OUTDOOR
PANELS/CLADDING**
Material: Wood and PVC Composite

**OUTDOOR
PANELS/CLADDING**
Material: Wood and PVC Composite



WPO-13
155x12mm



WPO-154
154x16mm



WPO-169
169x15mm



WPO-206
206x30mm



THO-26
245x23mm



WPO-194
194x30mm



WPO-170
170x9mm



WPO-24
204x15mm



WPO-147
147x14mm



WPO-95
104x15mm



WPO-181
181x60mm



WPO-218
218x57mm





Outdoor Deck

DECKING

Ecwood Decking - Durable, sleek, easy installation and low maintenance decking-it is the ideal product for indoor and outdoor use as it made to withstand the elements of nature.

Ecwood Decking can be installed into any design option virtually. The unique profiles offer dimensions in architectural design options whilst offering long term low maintenance durability.

PVC DECKING

Material: Wood and PVC Composite

COLORS



D-Cherry D-Walnut Weatherwood Teak



Rue Cherry-62 Ipe Red Teak



DBI-14
140x25mm



DBO-140
140x25mm



DBI-11
140x32mm



DBO-13
90x25mm



DBO-121
121x12mm



DBI-05
84x11mm

HDPE DECKING

Material: Wood and HDPE Composite

COLORS



Coffee Wood Black

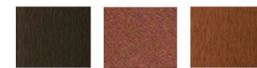

Grey Mocha Cedar



EW-26
105x30mm



EW-R01
140x25mm



EW-R02
140x25mm

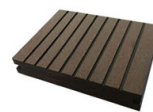

EW-D01
140x22mm

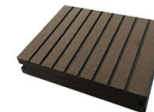

EW-D03
145x25mm



EW-D04
122x22mm

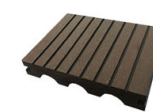

EW-D05
140x23mm



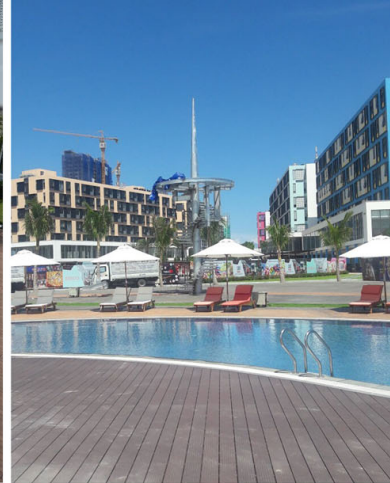

CO-EXTRUSION DECKING

Material: Wood and HDPE Composite
with a "durable" exterior layer of vinyl (PVC)

COLORS



Brown Coffee Grey Light grey Iron red



EW-C01
140x23mm



EW-C04
143x21.5mm

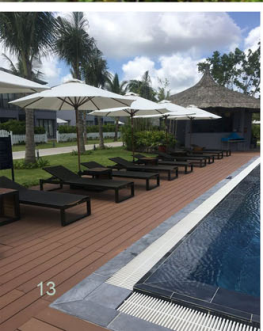

SUN SHADING - PERGOLA

Material: Wood and PVC Composite

Ecwood Sun Shading - Pergola products can effectively reduce the solar radiation and refraction, because of its exceptional low thermal conductivity. Meanwhile, it provides a variety of creative space to designers, optimizing thermal comfort and keeping indoor scenery visible.



PSO-120
120x120mm



PSO-100
100x100mm



FSO-15035
150x35mm



FSO-100
100x50mm



FSO-10B
100x50mm



FSO-10035
100x35mm



FSO-180
180x80mm



FSO-150B
150x50mm



FSO-150
150x50mm



FSO-10025
100x25mm



FSO-7550
75x50mm



FSO-6525
65x25mm

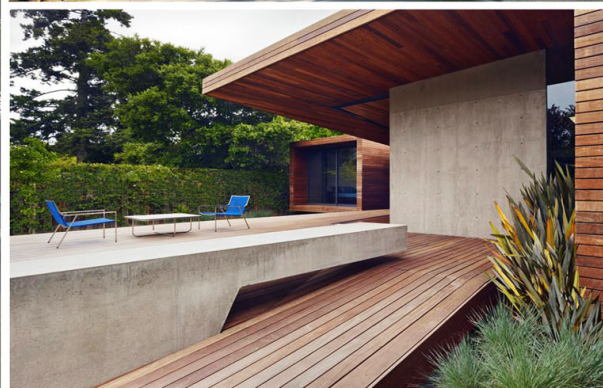
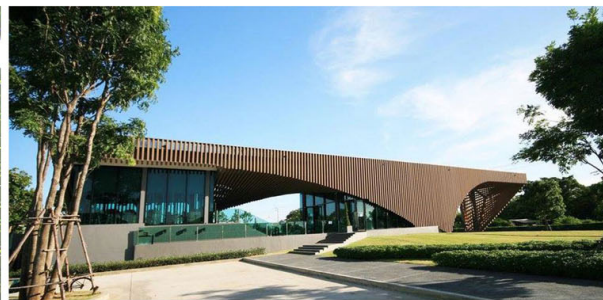



SUN SHADING - PERGOLA

Material: Wood and PVC Composite



FSO-50
50x50mm



FSO-4050
40x50mm



FSO-5025
50x25mm



FSO-4025
40x25mm



FSO-60
60x60mm



FSO-35
35x35mm



FSO-20
20x20mm



QBO-29
70x20mm



LPO-9018
90x18mm



LPO-15238
152x38mm



FTI-02
75x75mm



XTI-14
60x15mm



FSO-20030
200x30mm



FSO-25035
250x35mm



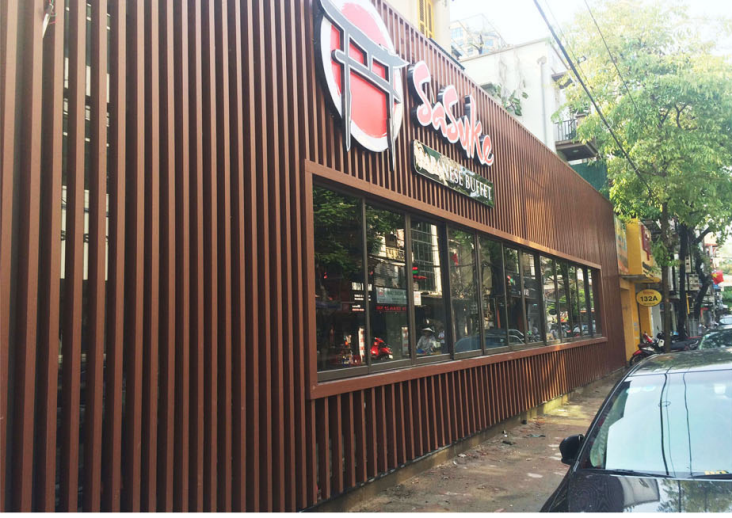

SUN SHADING - PERGOLA

Material: Wood and PVC Composite

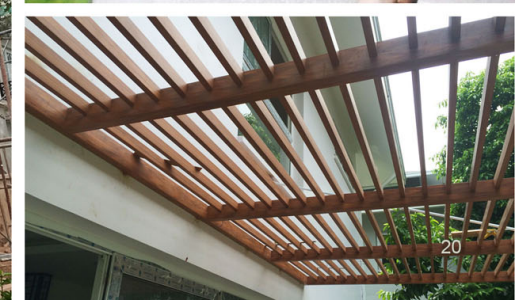
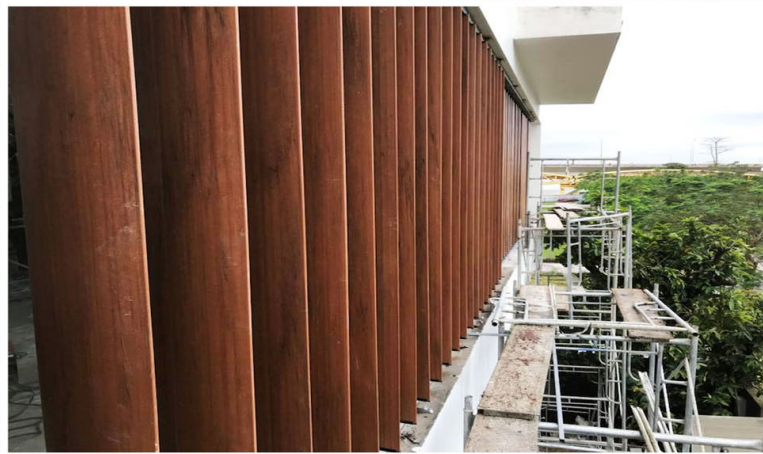
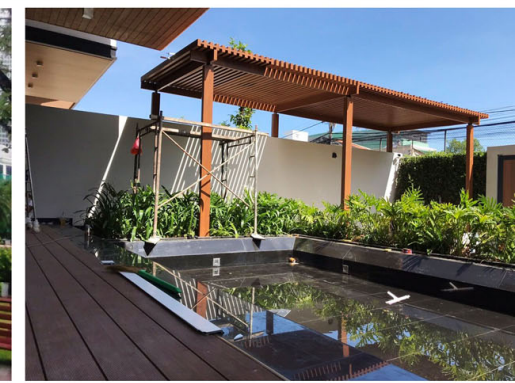

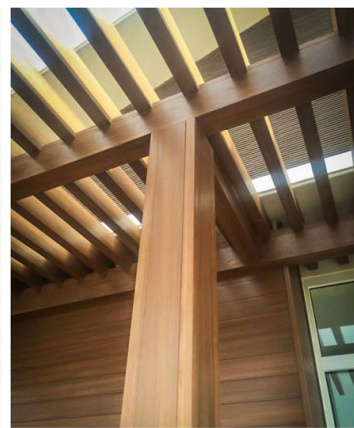

CEILING

Material: Wood and PVC Composite



THO-200
200x50mm



THO-150
150x50mm



THO-15040
150x40mm



THO-16
100x40mm



THO-80
150x80mm



CLI-75
75x50mm



CLI-55
55x40mm



CLI-10030
100x30mm



THO-08
80x40mm



THO-120
120x100mm



YXT-09
100x50mm



THO-09
40x45mm



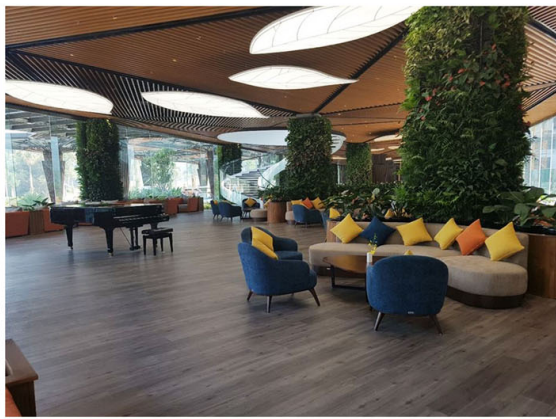

CEILING

Material: Wood and PVC Composite



CLI-70
70x60mm



THO-8055
80x55mm



THO-05
50x25mm



THO-5030
50x30mm

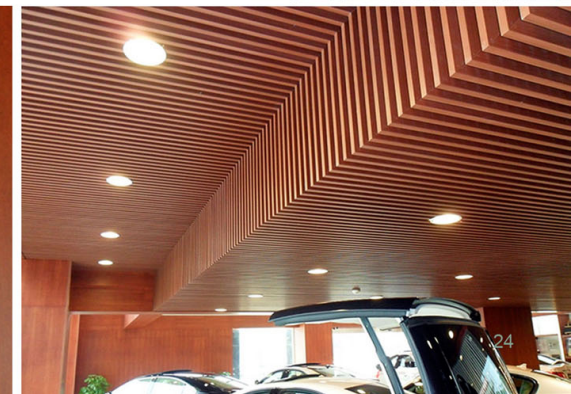
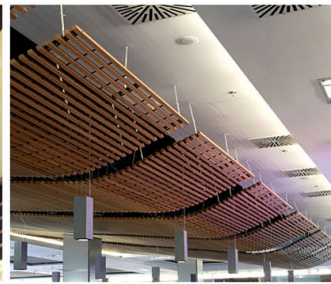
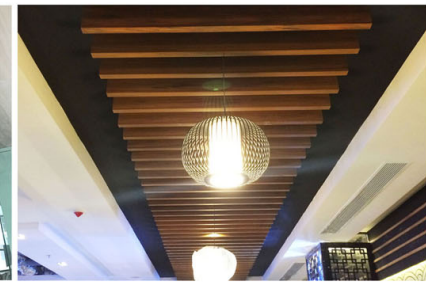
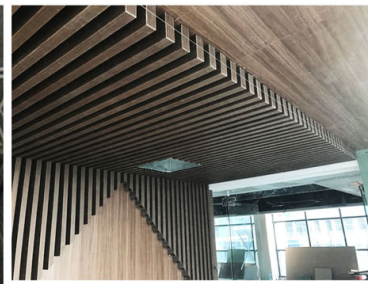
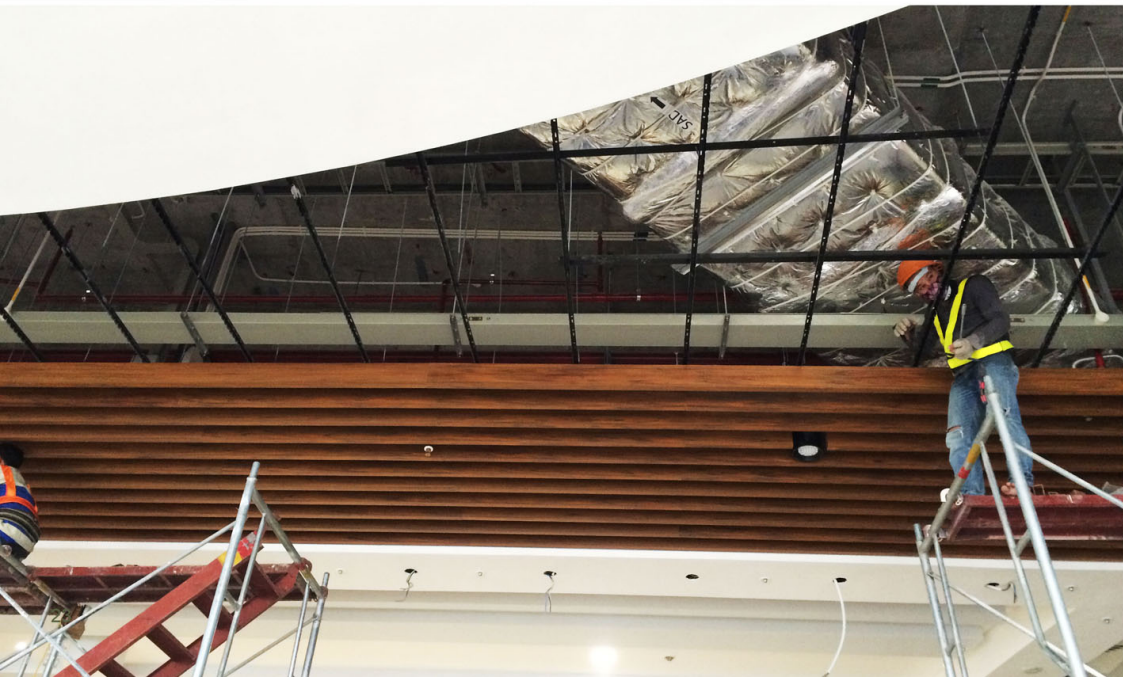
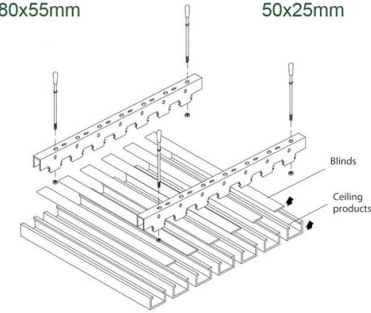
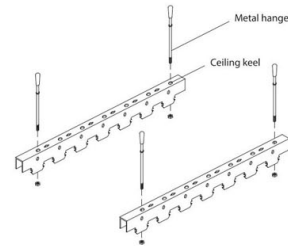

FENCING - RAILING

GATES



FSI-02
33x102mm



BKI-10
75x50mm



CLI-70
70x60mm



FSI-03
68x45mm



BKI-90
90x90mm



BKI-162
162x90mm

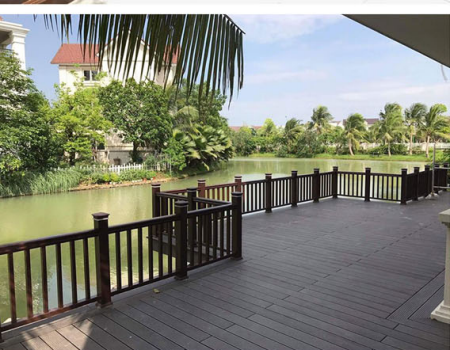
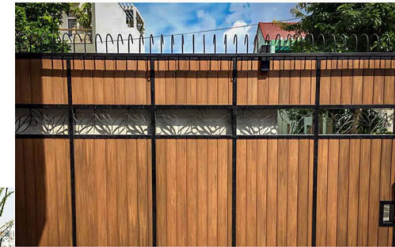
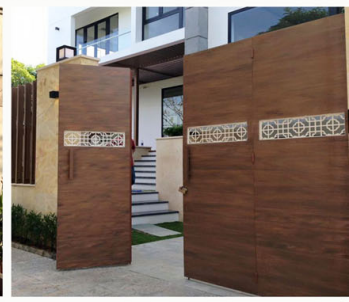

HUTS

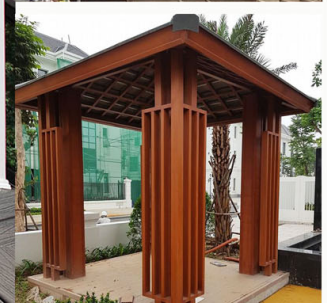



FLOORING

Material: Wood and PVC Composite with a "durable" exterior layer of vinyl (PVC)

WPC flooring, with its eco-friendliness and free of formaldehyde and heavy metal elements, has become a popular choice for interior home decoration. With its various wooden grain and colors suitable for different household styles, we are confident to help you create a healthy and warm house for you.

- Abrasive resistant, self-clean, environment protect;
 - Fire resistant and mute noise;
 - Resist impact, anti-skidding and shock absorbing;
 - Restrain the exist of mould, form-stable, anti-cracking and low in swell ratio;
 - Soft and comfortable, high resilience;
 - Completely waterproof;
 - Dramatic different planks, with deep embossing and handscraped;
- Good moisture resistance



Size as below

- 1220x176x6.2mm
- 1220x176x8mm
- 914x147x8mm
- 1220x176x12mm



COLORS



DECORATIVE GARDEN

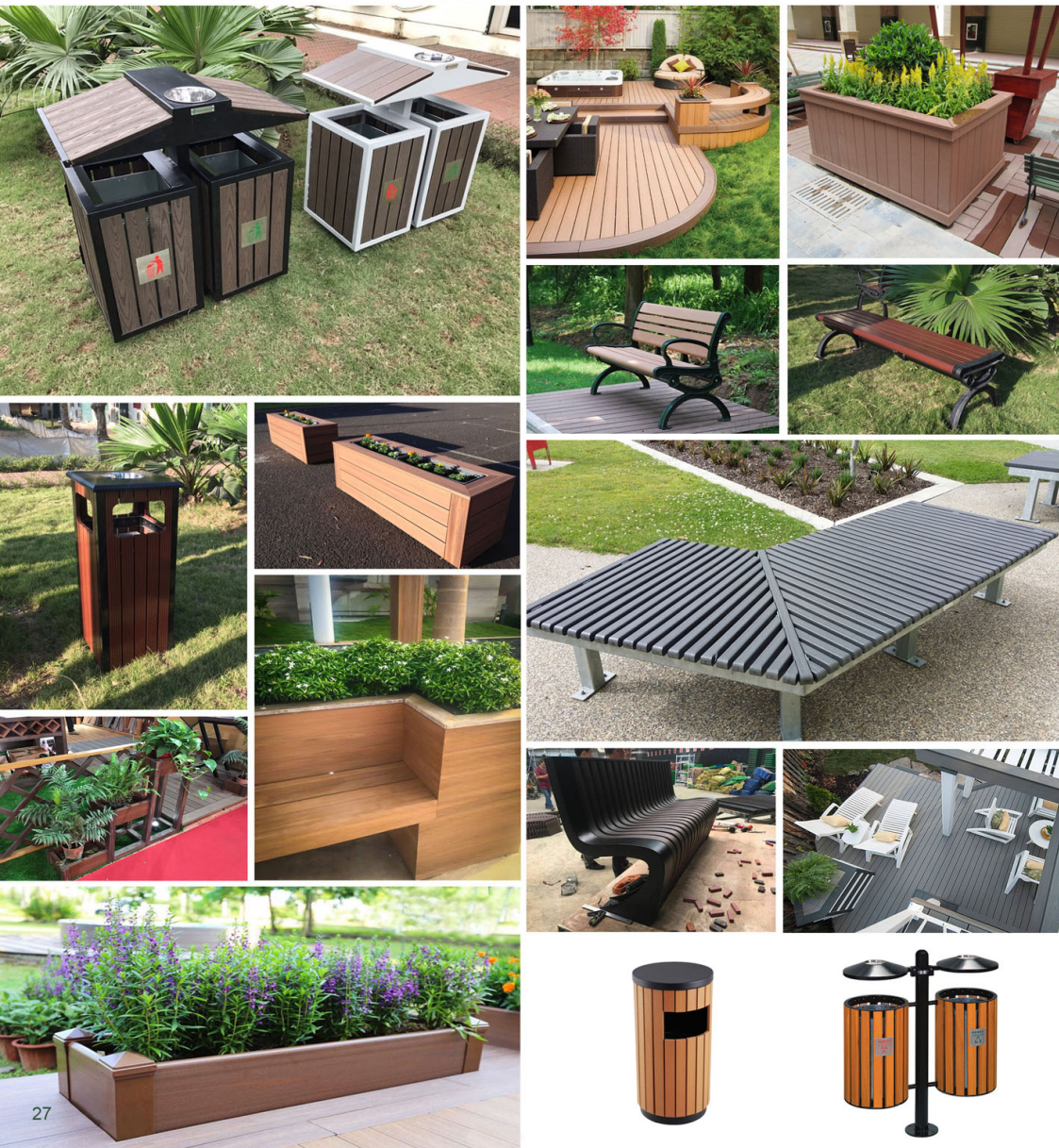

FINISHING ACCESSORIES



PRODUCT	APPLICATION	PRODUCT	APPLICATION
 E40 40x40mm	CLADDING	 E40H25 40x25mm	DECKING
 E5030 50x30mm	CLADDING	 E60H25 60x25mm	DECKING
 E25 25x25mm	CLADDING	 EW-50 50x50mm	DECKING
 E3321 33x21mm	CLADDING	 EW-TN01 35x55mm	DECKING
 XTO-14 19x19mm	CLADDING	 EK-01 12x10mm	DECKING
 XTI-16 50x30mm	CLADDING	 XTO-90 90x18mm	LOUVER
 EC-2034 20x34mm	CLADDING	 E25H25 25x25mm	CEILING
 XTO-11 42x40.5mm	CLADDING	 WPO-503 50x3mm	CEILING
 EW-3008 30x8mm	CLADDING	 ENK-01 50x35x2mm	CLADDING



The Singapore Green Labelling Scheme hereby certifies

ECO WOOD - WOOD PLASTIC COMPOSITE
043-013-1297
"Product Made From At Least 50% Recycled Content"

Date of Expiry: 15 July 2015

JOISE RAYMOND
Executive Director
Singapore Environment Council



Use the QR app on smartphone to authenticate the certificate

Wood Plastic Composite Manufacturer
Khác biệt trong mọi không gian